

ELEVATION 01

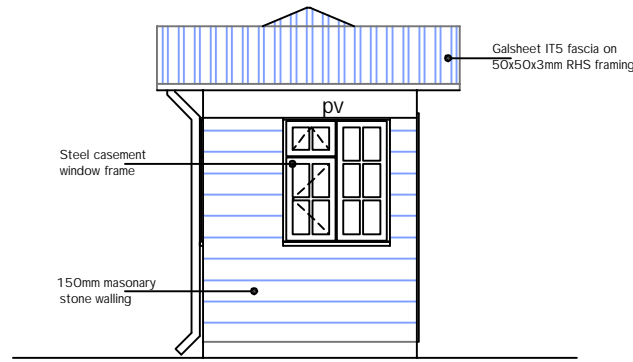

ELEVATION 02

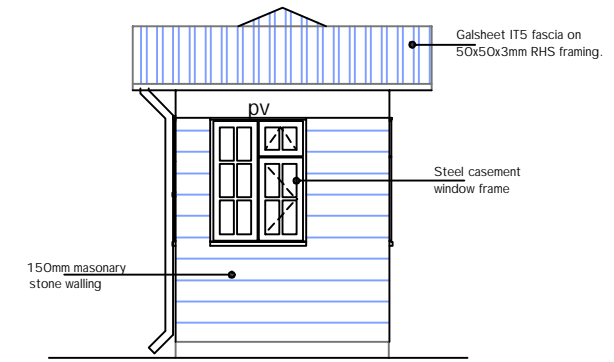

ELEVATION 03

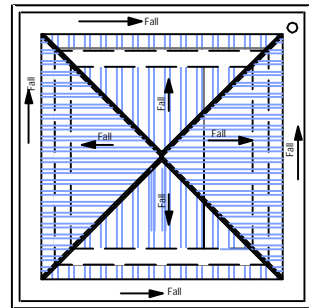

ROOF PLAN

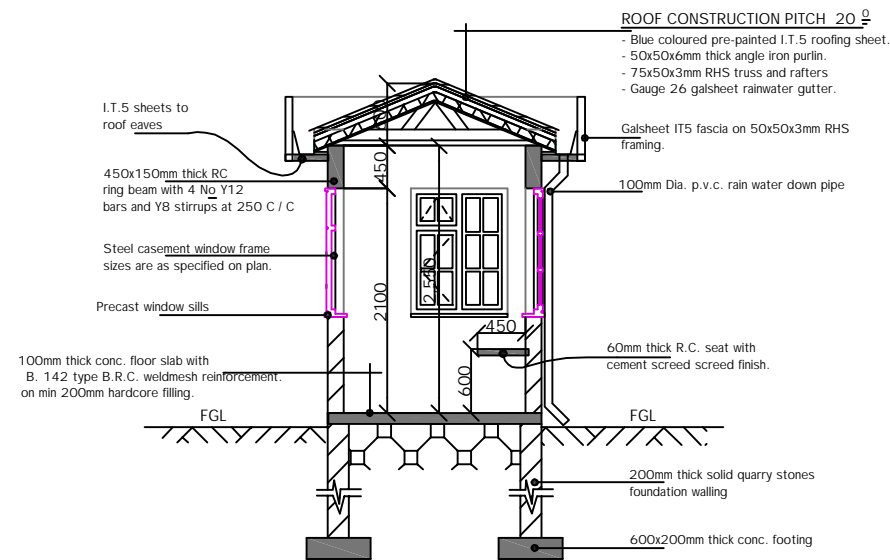

SECTION A - A

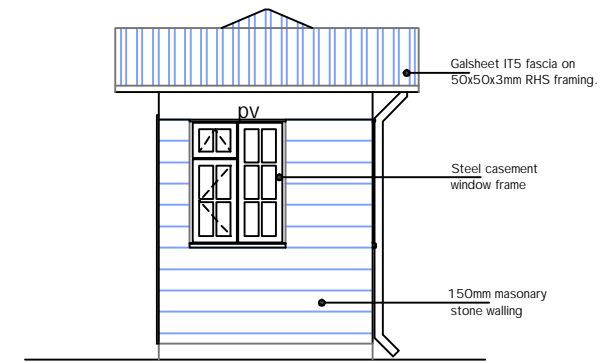

ELEVATION 04

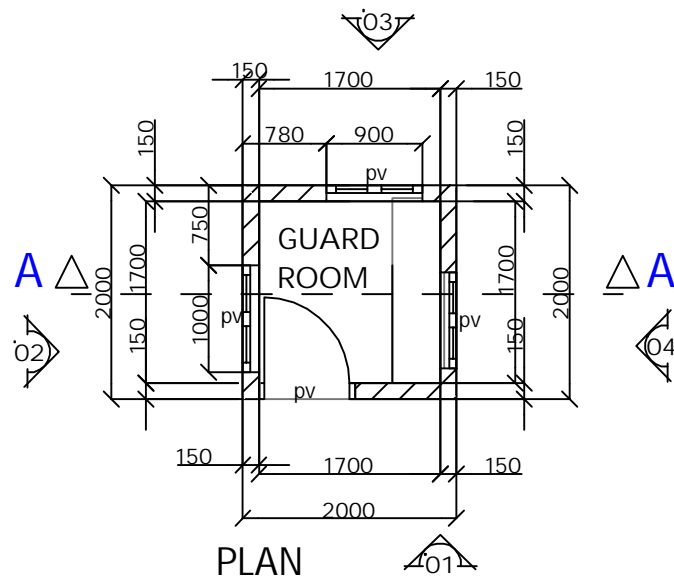

PLAN

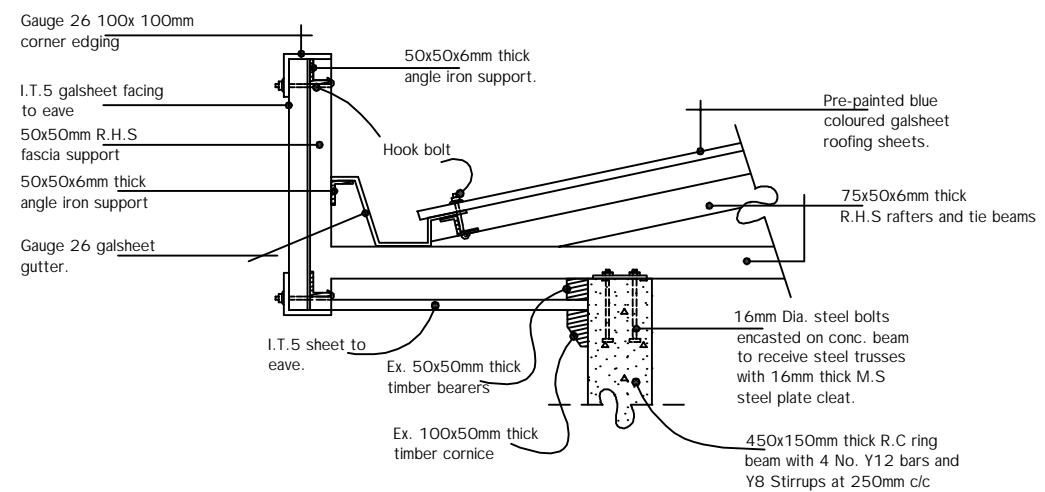

EAVE DETAIL

	NAME	DATE	SIGN
APPROVED			
CHECKED ENGINEER I/C			
CHECKED PRINCIPAL D/MAN	B. GAITHO		
DRAWN	J.M.Kahare	23/02/2010	Kahare
TRACED			

REF	REVISION	DATE	SIGN	CHECKED	DATE
1					
2					
3					
4					
5					
6					

## DETAILS OF GUARD HOUSE AT PRIMARY SUB - STATION

SCALE 1 : 50

SHEET 3B



K.P.&.L.Co.Ltd

SK. No. 09847/A